

Panel Raise Cutter

RNCP335

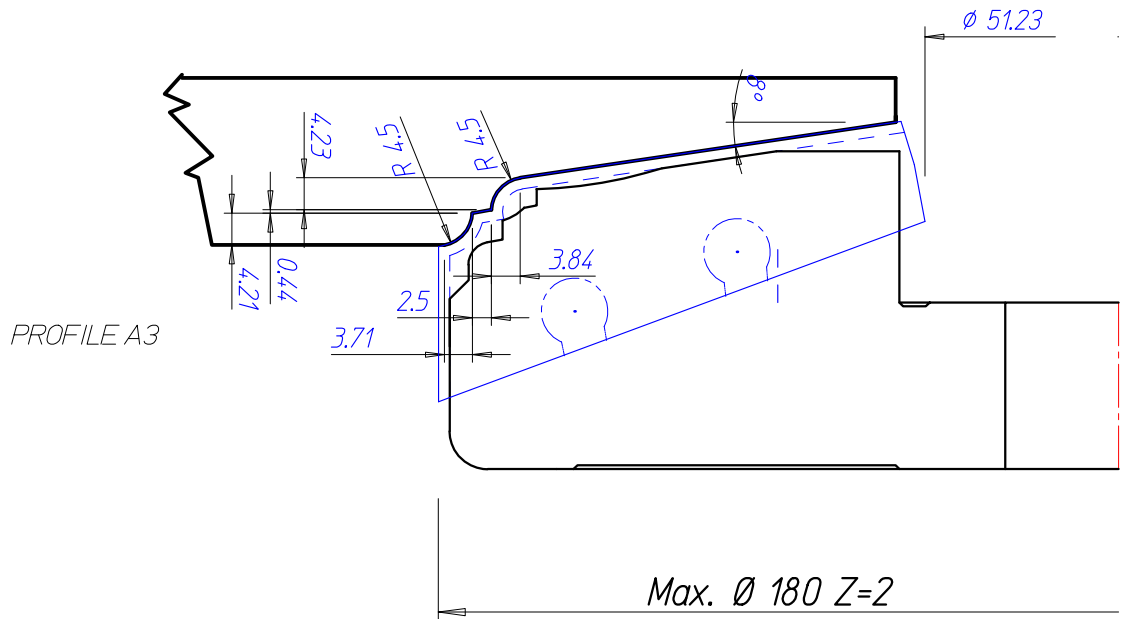

Profile Options

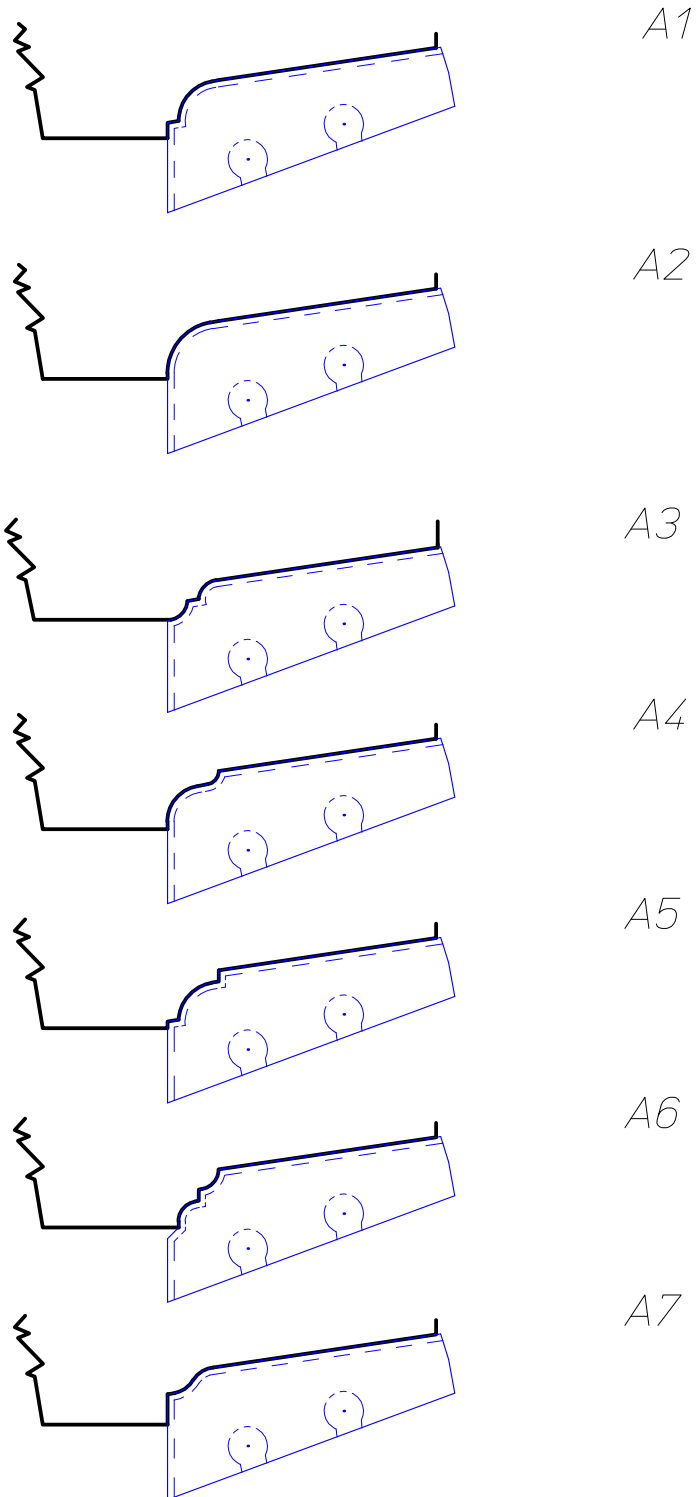

Profile Options

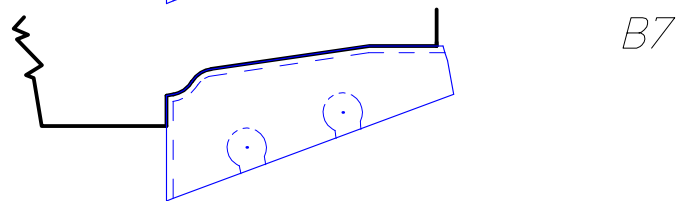
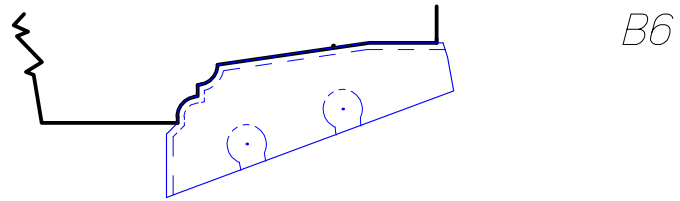
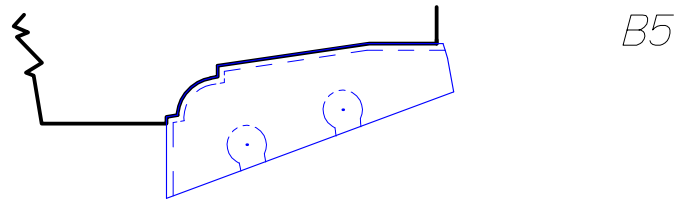
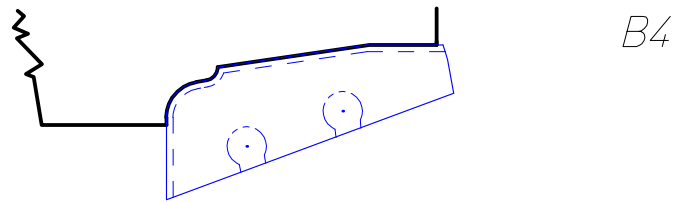
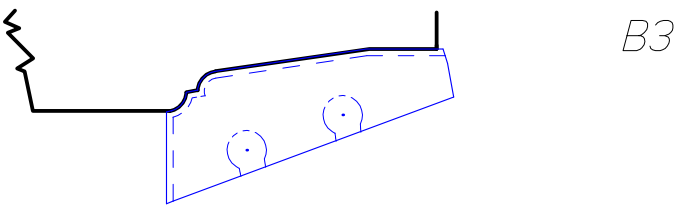
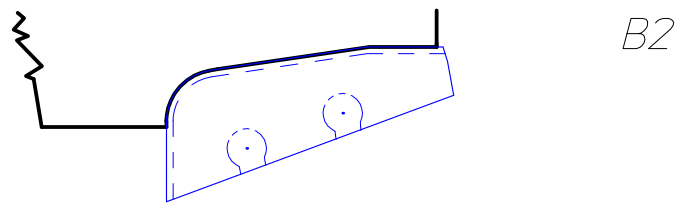
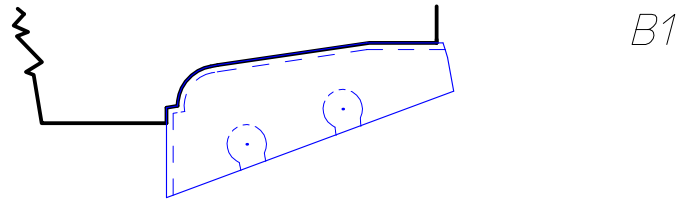

Profile Options

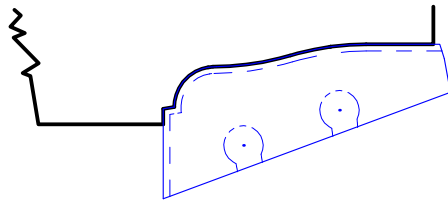

C1

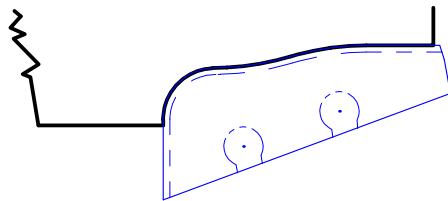

C2

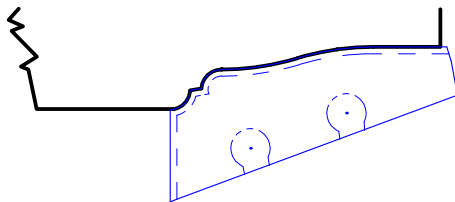

C3

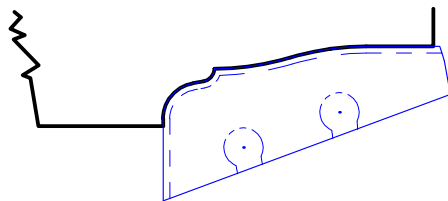

C4

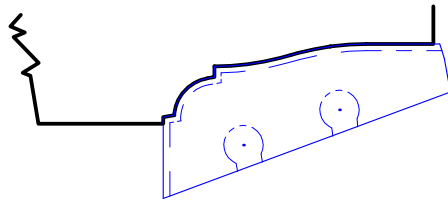

C5

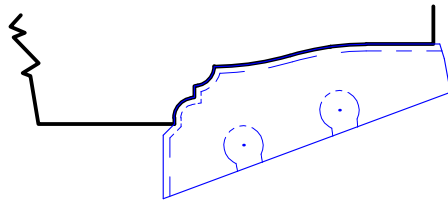

C6

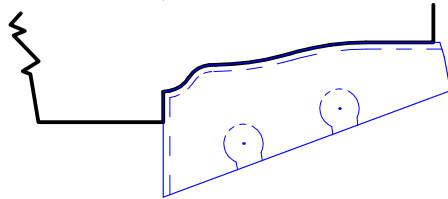

C7